

MODEL DL900A
 900lb/409kg CAPACITY
 PULLING WINCH

FRONT & SIDE VIEW

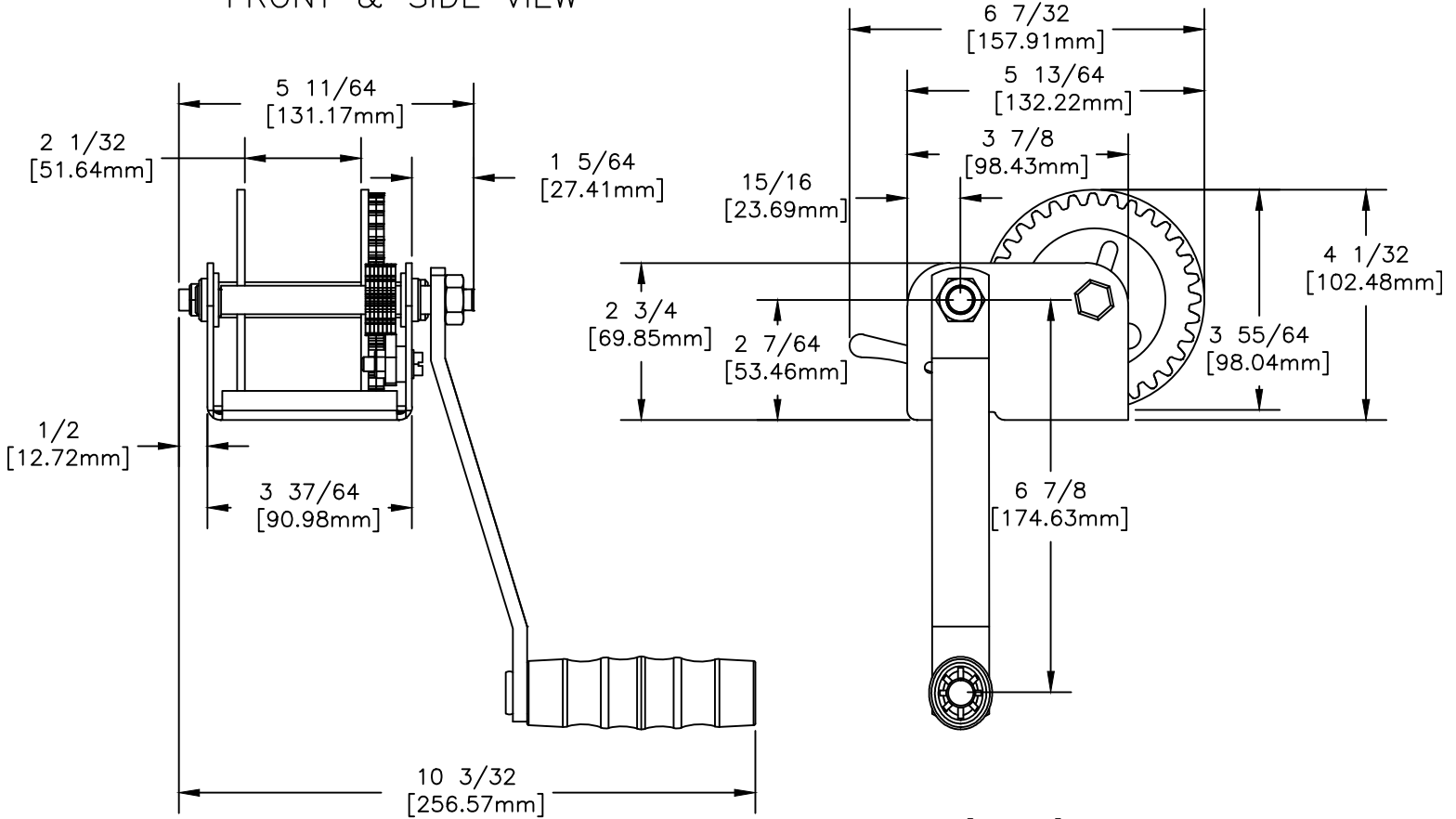

BASE HOLE PATTERN

