

FRONT & SIDE VIEW

MODEL DL1100A
 1100lb/499kg CAPACITY
 PULLING WINCH

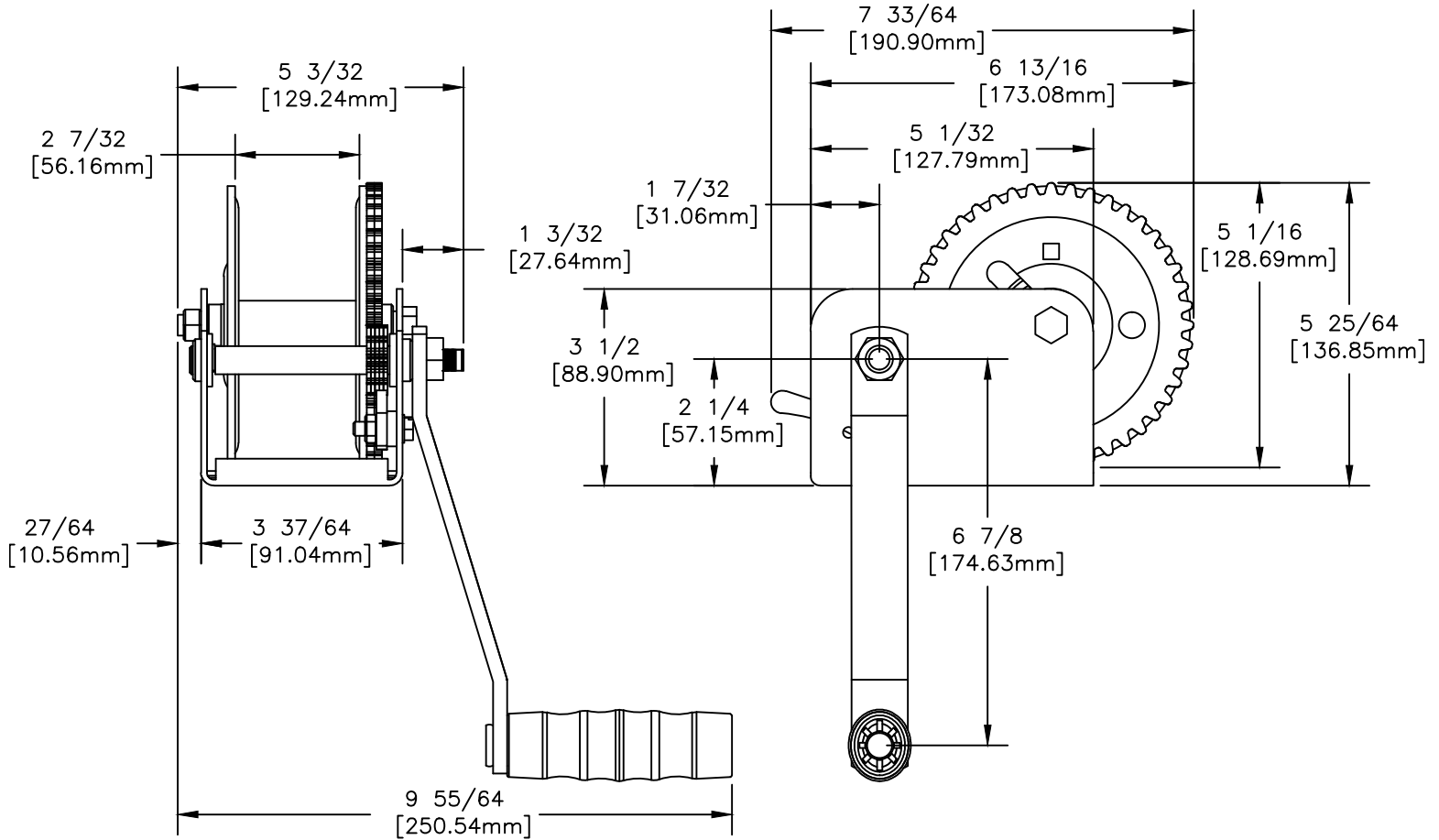

BASE HOLE PATTERN

