

MODEL
 CD3500
 DRUM HUB DIA. - 2 INCH
 GEAR RATIO - 11.5:1
 SINGLE LINE CAPACITY - 1750 LB/794 KG
 DOUBLE LINE CAPACITY - 3500 LB/1588 KG
 BOAT LIFT WINCH

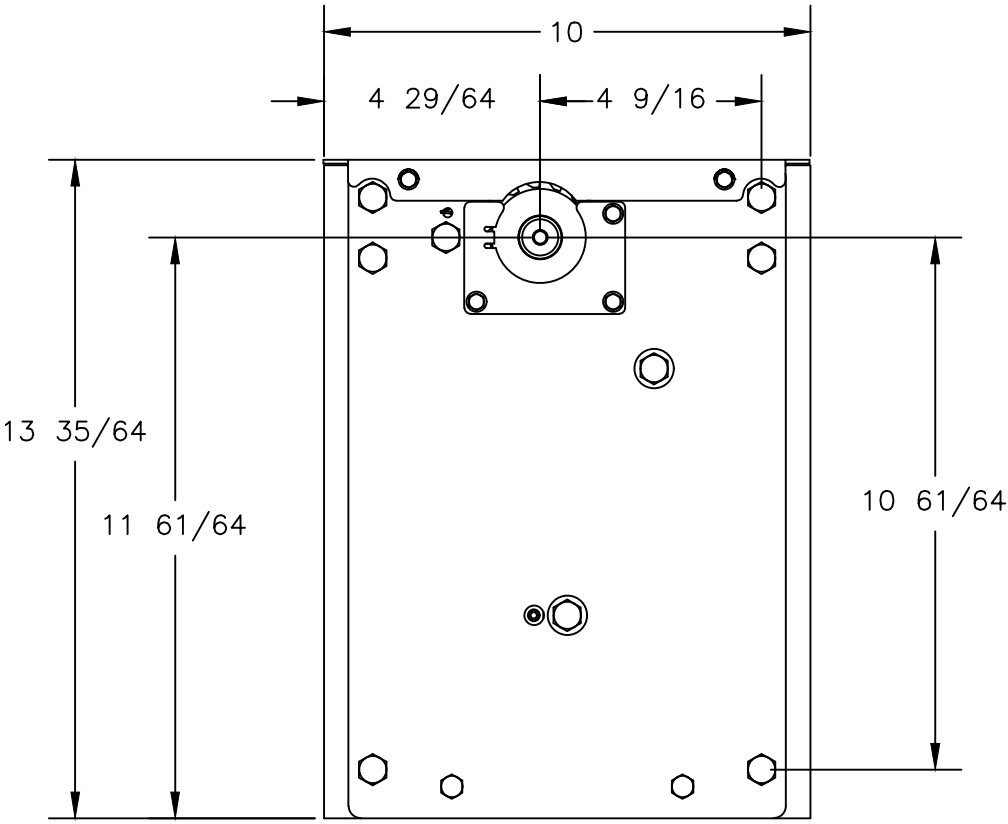

FRONT VIEW

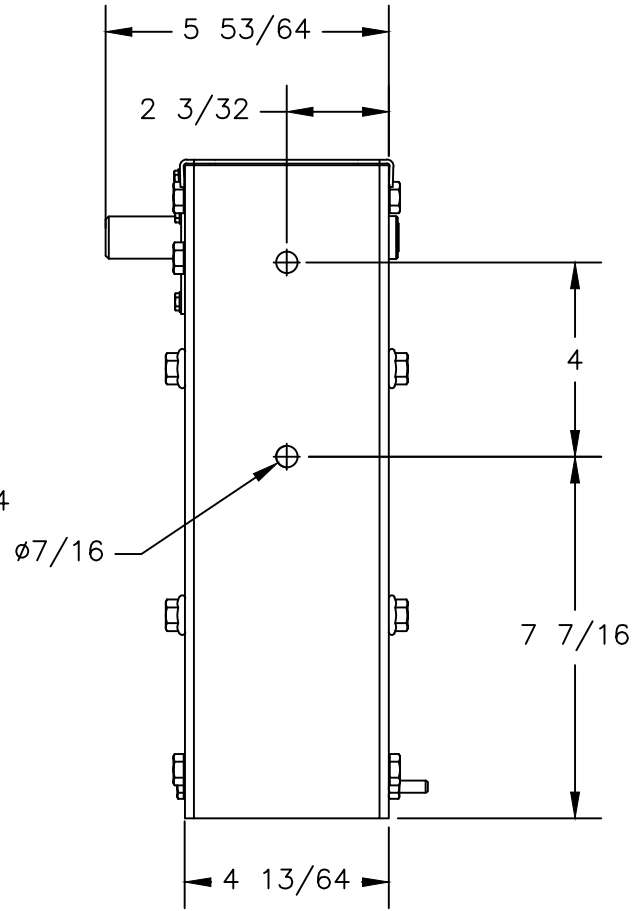

SIDE VIEW
 (MOUNTING HOLE
 PATTERN SAME ON
 BOTH SIDES)

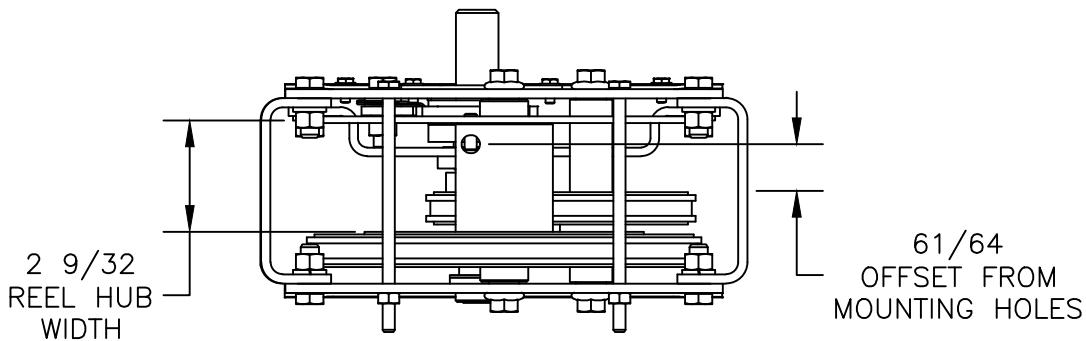

BOTTOM VIEW